

## Installation and Operating Instruction for B.E.G. - Occupancy detector Indoor 180-M-2C

### 1. Product information

- Wall-mounted occupancy detector
- 2 switching channels (channel 1 to the switch of light, channel 2 potential free 3A for device control)
- Available as Master
- Extension of the coverage area by slave devices are possible
- Manual switching via externally push-button possible
- NEW: Integrated acoustic sensor
- Other functions can be adjustable by remote control.

### 2. Operation

The presence detector controls the light automatically according to people present (movements) and the ambient brightness.

The integrated light sensor constantly measures the ambient light and compares it with the brightness level on the detector. If the ambient light is sufficient, lighting will not be switched. If the ambient light level is below the brightness level, a movement activated the lighting in the room.

The detector switch the light off instead of a person, if there is enough natural light for 15 min. or until the follow-up time do not recognized any movement in the room.

In addition to movement detection, the device is also equipped with an adjustable acoustic sensor, the follow-up time extended automatically when sound is detected. For switching on a detected movement is always required. The acoustic sensor stays during the follow-up time and 9 seconds after the lights turn off active.

### 3. Safety information

- ⚠ **Work on the 110-240V mains supply may only be carried out by qualified professionals or by instructed persons under the direction and supervision of qualified skilled electrical personnel in accordance with electrotechnical regulations.**
- ⚠ **Disconnect supply before installing!**
- ⚠ **This device is not suitable for disconnection.**

### 4. Mounting

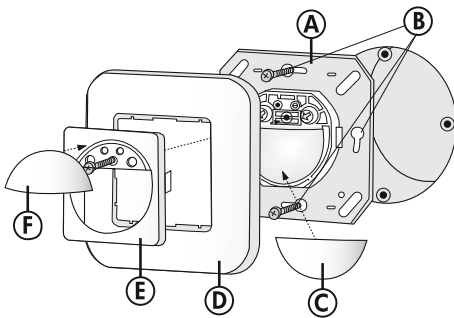

Disconnect mains supply.

- (A) Sensor insert
- (B) Mounting screws
- (C) Blinds for the exclusion of interference sources (Animals, small children ...)
- (D) Frame
- (E) Cover
- (F) Cover cap

⚠ In Master-/Slave-operation the master device must always be installed at the site with less daylight.

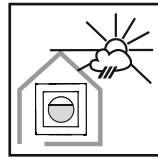

Install the unit in a protected position, for wall mounting at a height of 1,10 m to 2,20 m.

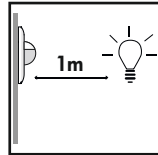

Minimum distance to lighting being controlled, to the front or to the side of the unit: 1 m

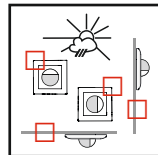

Inappropriate installation or use will interfere with trouble-free operation or lead to damage to the unit.

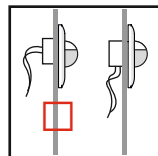

Suitable for installation in a 60 mm flush-mounted box. The cable inlet should be vertical.

### 5. Hardware configuration

Position Potentiometer's and LED's

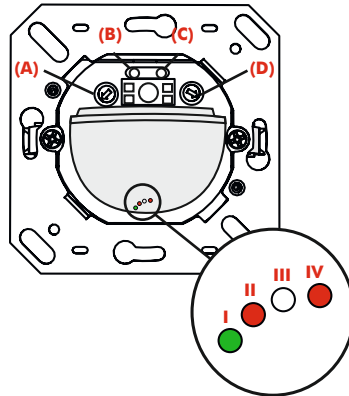

- Potentiometer (A): Potentiometer Brightness setting
- Potentiometer (B): Potentiometer Acoustic sensor
- Potentiometer (C): Potentiometer Follow-up time Channel II
- Potentiometer (D): Potentiometer Follow-up time Channel I

- LED I: green
- LED II: red
- LED III: white
- LED IV: red (Acoustic sensor)

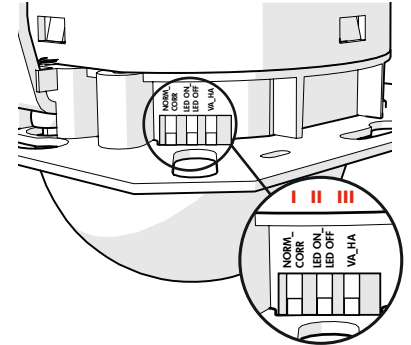

DIP-switch function		
DIP 1	Normal mode	Corridor mode
DIP 2	LED ON	LED OFF
DIP 3	Fully automatic mode (VA)	Semi automatic mode (HA)

### 6. Self test cycle/Startup behavior

The product enters an initial 60-second self-test cycle, when the supply is first connected. During this time the device does not respond to movement and stays on (INI-ON or INI-OFF).

### 7. Putting into operation / Settings



#### Follow-up time for light control

The time can be set infinitely variably between 15 sec and 30 minutes.

Symbol TEST: Test mode

Every movement switches on the light for a period of 2 second, switching it off for a period of 2 seconds.



#### Twilight-switch

The switch-on value for the light can be set at between 10 and 2000 lux. Using the rotary control, the luminance set points can be set as desired.

Symbol ☾: Night-time operation

Symbol ☀: Daytime operation

#### Determine the current brightness value

Set potentiometer 2 in position TEST.

The green LED glows continuously, as soon as the value of potentiometer 1 exceeds the current measured brightness value.



#### Follow-up time for device control

The follow-up time can be set infinitely variably at between 5 and 120 minutes. From a set period of >15 minutes, the delay is active.

This is about 5 minutes.

If there are no further movements detected in this time, the delay time restarts.

Symbol : Impuls = 2.5 s

Symbol A: Alarm impuls = 2 s

#### Alarm impuls

To initiate an alarm impuls, there must be recognized 3 movements, distributed over a period of 9 seconds



#### Acoustic sensor

The sensitivity of the acoustic sensor is infinitely adjustable with the rotary control (Left position = max. sensitivity, Right position = acoustic sensor off). The response of the acoustic sensor is signaled via LED IV.



#### Dip switch

NORM/CORR: Activate or deactivate the corridor function

LED ON/OFF: Activate or deactivate the LED function display

VA/HA: Activate or deactivate the full or semi-automatic.

### 7.1 Mode Semi-Automatic (HA) / Automatic (VA)

#### Automatic

The Indoor 180-M-2C is set to Automatic as its factory setting. In Automatic mode, the light must always be turned on via the switch. The light automatically turns off when ambient light is sufficient or when there is no movement.

The light can also be manually turned on or off via push button. The lights will remain on or off as long as the device no further movement detected and the follow-up time has expired.

After that the device switched again into automatic mode.

#### Automatic with Corridor function (VAC)

In corridor mode, temporary switching the lighting off by pressing the switch is disabled, i.e. in contrast to normal operation, the unit immediately returns to automatic operation after manual switching off, and will switch the lighting on again automatically if there is movement and when brightness levels are below the threshold.

**Reference:** With activation of corridor function the Party function automatically is blocked

#### Semi-Automatic (HA)

In the semi-automatic mode the light must always be switched on manually via an external button. The light will automatically turn off if there is sufficient light, missing movement or noise. If the device turns off because of missing any movement or sound, it will execute an automatic restart, by a detected movement or noise in a time window of 10 seconds, otherwise a manually turn on is required by pushing the push button.

### 7.2 Brightness threshold

If the lighting is on, and daylight levels are above the previously-set room brightness level for 15 min, then the lighting will be turned off, even if people are present in the room.

#### Learning phase

When the unit is first used, and after every subsequent change to the room brightness on the adjustment screw, the artificial light level of the connected lighting will be determined automatically by the unit during a 5-minute learning phase. For this purpose, the lighting will be switched off after the first 5 minutes have elapsed. During the learning phase, the green LED lights up for 1 sec every 10 sec.

### 7.3 Manual switching

#### S-terminal:

By pressing the pushbutton, the phase can be given to the S terminal.

To turn on or off, press the light briefly. The light will remain on or off, as people are detected plus the follow-up time.

#### R-terminal:

The R terminal is used for connecting the slave to the master. Alternatively, the phase can be set by a switch on the R terminal. If the phase is longer than 10 sec. on, the detector switches to permanent mode, as long as the pushbutton is closed.

### 7.4 Factory setting

For a quick start, the device has a fixed factory setting. At the factory setting the device operates according to the following default parameters:

Starting value channel 1 (light): 500 lux (ambient brightness)

Follow-up time channel 1 (light): 10 min

Follow-up time channel 2 (HVAC): 15 min, (without delay)

The work program is only active if the adjusting screws of the device, with connected power supply, are set on the positions of "sun" and "test" and no individual settings for the switch ON or the follow-up time were made for channel 1 with the remote control. The active factory setting is shown at the beginning of the initialization phase for 10 s by a LED sequence white-red-green. When changing the settings over the adjusting screws or via the remote control, the factory program is switched off.

### 8. Wiring diagram

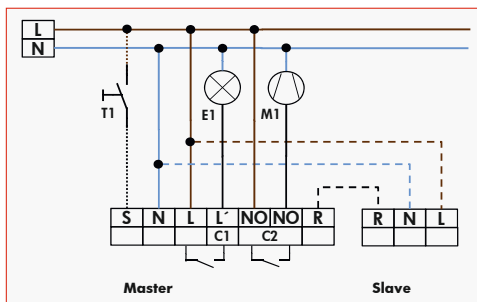

T1 = NO button for semi-automatic mode Slave for enlargement of detection area

### 9. Range

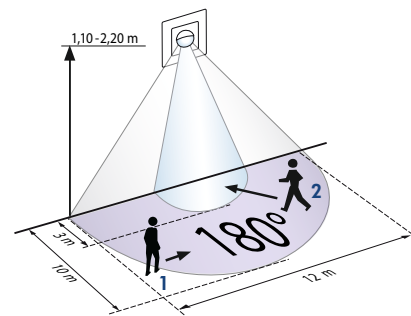

- 1 Walking across
- 2 Walking towards

### 10. Exclude sources of interference

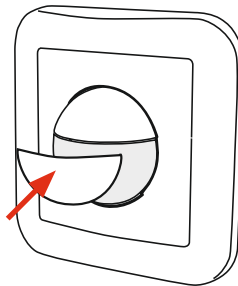

To hide the detection area below the detector ( f.e. animals/small children), the enclosed Blind can be mounted or attached on it.

### 11. Technical data

**Power supply:** 110 – 240 VAC, 50/60 Hz

**Power consumption:** ca. 0,5 W

**Umgebungstemperatur:** -25°C – +50°C

**Degree of protection/class:** IP20, mit Zubehör IP54 / II

• **Channel 1 for light control**

**Switching power / contact:** 2300 W, cos φ= 1  
1150VA, cos φ= 0,5 μ-Contact  
NOC/with pretravel  
tungsten contact

**Follow-up time:** 15 sec. to 16 min./Test adjustable with potentiometer  
5 min. - 30 min./ Test adjustable with remote control

• **Channel 2 control devices (only reacts on motion)**

**Contact load:** 230 VAC, 3A cosφ=1

**Time-settings:** 55 min. - 120min. with time delay of 5min. for follow-up time > 15min./ Alarm impulse

#### Range of coverage

Ø H 1,10 m / T = 18°C: tangential 10 m / radial 3 m

**Area of coverage:** semicircular 180°

**Dimensions:** H 87 x B 87 (with cover frame)

CE **Declaration of Conformity:** The product complies with the low voltage recommendation 2006/95/EC and the EMV recommendation 2004/108/EC.

### 12. Article / Part nr. / Accessory

Typ	Art.-Nr.
Indoor 180-M-2C, fully fitted	92136
Indoor 180-S, fully fitted	92135
Sensor insert for Indoor 180-M-2C	92661
Sensor insert for Indoor 180-S	92660

#### LUXOMAT® Remote control:

IR-PD-2C (incl. wall bracket) 92475  
IR-PD-Mini 92159

#### Accessory:

Covering IP20 pure white, RAL9010 92630  
Covering IP20 traffic white, RAL9016 92641  
Covering IP20 cream white, RAL1013 92632  
Covering IP20 silver, RAL9006 92633  
Covering IP20 anthracite, RAL7021 92634  
Covering IP54 pure white, RAL9010 92139  
SM-Socket for Indoor pure white, RAL9010 92141

### 13. LED-functional indicators

LED function indicators after each mains recovery (60sec. initialisation period)	
Operating state	LED function indicators
Factory program active	White, red and green flash in quick succession for 10 sec., then initialisation indicators, see below
	Indicator unprogrammed
Standard mode	Red flashes

LED function indicators during operation	
Process	LED function indicators
Motion detection	Red flashes on each detected movement
Too bright detected	Green flashes
Light measurement active	Green flashes once every 10 sec.
Semi-automatic active	White fleashes
Corridor active	white on 1s and 4s from
Corridor and semi-automatic active	white 4s and 1s

## 14. Settings by remote control when open



Settings with remote control override the potentiometer and DIP settings.

The DIP settings are reactivated by

- Reset with Test-Sun setting at the potentiometers
- "RESET" in the opened state

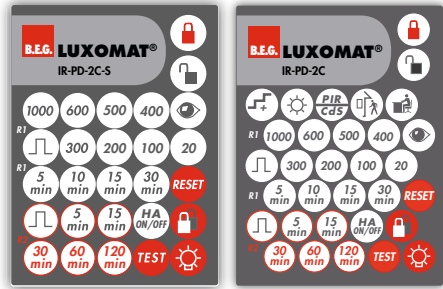

IR-PD-2C-S

IR-PD-2C



Wall bracket for remote control IR-PD

## 15. Settings by remote control when open

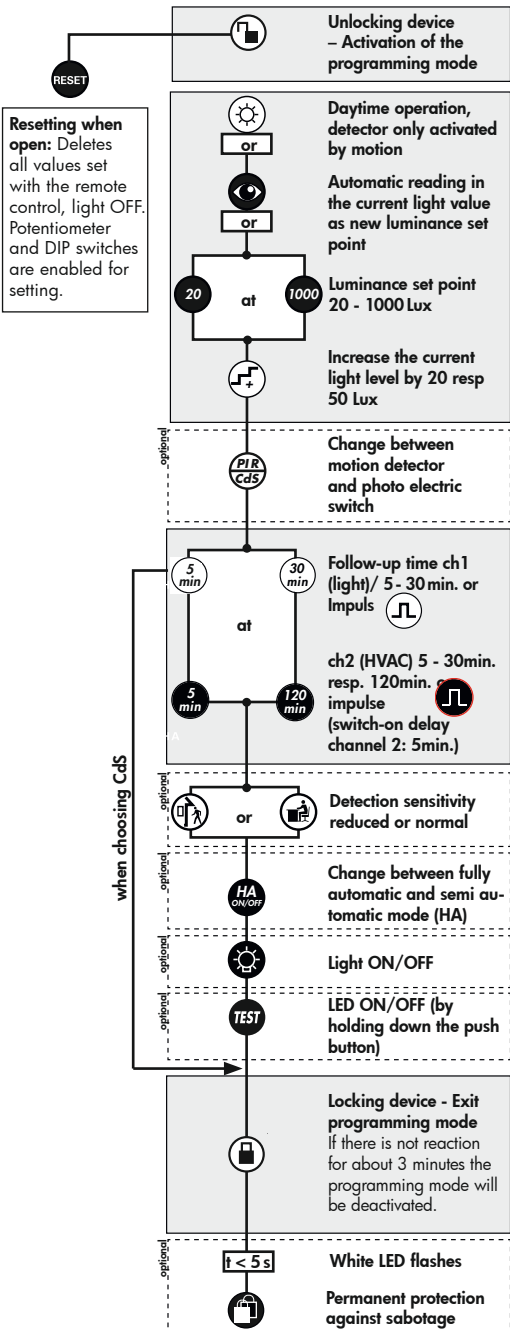

## 16. Key functions in closed state



### Permanent protection against sabotage

This function blocks the unit permanently. This operating mode can only be activated during the period of 5 seconds (white LED flash) after pressing the "lock" button. The procedure for leaving this mode is as follows:



1. Switch off the current
2. Apply current for 31 - 59 seconds
3. Switch of the current again
4. Apply current, wait for selftest cycle
5. Open detector



### Light ON/OFF during the detection of motion plus follow-up time; Activation of the 12 h-ON/OFF-function by holding down the push button



#### Activation/Deactivation of the test function

After 3 min. the test mode will be automatically closed.



### Switches channel off and is immediately active again, exits all timers, interruption of light measurement



#### Confirmation



#### Changes to "open" state

## 17. Explanation of the remote control button functions

### 17a. In the initialisation period

#### INI-OFF/ON-Mode:



Lights can be set to on or off status during initialization (60 Seconds) by using INI OFF/ON mode.



#### 12 h Light ON/OFF (party function)

Activated by "Light" - push button



Deactivated by "Reset" - push button (default)



#### Corridor function

Activated by "outside" - push button



Deactivate by "inside" - push button (default)



#### Forced shutdown

Activated by "sun" - push button



Deactivate by "moon" - push button (default)

### 17b. In opened state



This push button opens the detector and the following functions can then be programmed.

**Attention:** The detector is closed automatically:

- after every voltage recovery
- after 3 minutes



The state changes to "closed". In the first 5 seconds, the white LED flashes every 0.5 seconds. During this time, sabotage protection can be activated.

The device distinguishes between 2 procedures:

#### • Reading in with lighting switched on:

The switch-on value is determined automatically.



Determining the switch-on value:

1. Press the "eye" push button
2. Switch off the light (2 seconds later)
3. Read in the brightness
4. Switch-on value = Read brightness

#### • Reading in with lighting switched off:

When the push button is pressed, the current brightness is specified as the switch-on value. The switch-off value is determined automatically.



If the brightness has been modified, the switch-off threshold is recalculated.



Each time the push button is pressed, the device increases the current switch-on value in increments of 20 Lux for a current switch-on value of < 100 Lux and in increments of 50 Lux for a current switch-on value of > 100 Lux.



Standard sensitivity for most applications



Reduced sensitivity for outdoor applications



When the pulse function of channel 1 is active, a pulse of 1 sec. is generated every 9 sec. If the pulse function is activated via remote control, the pause between 2 pulses can be modified. After activating the function via the "Pulse" push button, select the desired time within 5 sec.:

(5 min) = 9 s, (10 min) = 10 s, (15 min) = 15 s, (30 min) = 30 s



The impulse function of channel 2 depends only on motion! After each movement the HVAC channel is activated for 2.5 sec.; time delay starts afterwards for 9 sec.



The "Test" push button can be used to set the LED ON/OFF function. To do this, hold down the push button for 3 sec.

**Please note** that in the open state and in test mode, the LED indicators are always ON.



### Twilight switch function (CdS)

If the CdS function is active, the detector acts as a simple twilight switch. Only the brightness can be set in this mode. Movements are no longer indicated by the red LED.

**The delay time between "dark-light" detection is 5 min.**

### Push button acknowledgement:

Each push of a button is indicated by lamp acknowledgement and by the white LED.

"Light ON" status: OFF/ON (approx. 0.5 sec. each)

"Light OFF" status: ON/OFF (approx. 0.5 sec. each)

## 18a. Behaviour of external push button/IR "Light"



The "Corridor" and "Light ON/OFF" functions are mutually exclusive. If both are activated, the detector performs the corridor function.

The behaviour when the push button is pressed is defined as follows:

### Corridor function activated

#### Light ON:

Push button pressed briefly (0,1 - 1 sec.): Light OFF -> Active after 5 sec.

Push button held down (> 3 sec.): Light OFF -> Active after 5 sec.

#### Light OFF:

Push button pressed briefly: Light ON as long as motion + Follow-up time

Push button held down: Light ON as long as motion + Follow-up time

## 18b. Behaviour of external push button/IR "Light"

### 12 h Light ON/OFF activated

#### Light ON:

Push button pressed briefly: Light OFF as long as motion + Follow-up time

Push button held down: 12 h OFF

#### Light OFF:

Push button pressed briefly: Light ON as long as motion + Follow-up time

Push button held down: 12 h ON

### 12 h Light ON/OFF deactivated

#### Light ON:

Push button pressed briefly: Light OFF as long as motion + Follow-up time

Push button held down: Light OFF as long as motion + Follow-up time

#### Light OFF:

Push button pressed briefly: Light ON as long as motion + Follow-up time

Push button held down: Light ON as long as motion + Follow-up time

## 18c. Behaviour of external push button/IR "Forced shutdown"

### Forced shutdown active

#### Light OFF:

Light OFF: Push button pressed briefly: Light ON for approx. 30 min., then forced shutdown if the set brightness is still exceeded.

## 19. Manual Switching



You can switch the lighting on and off manually by pressing the pushbutton for a short time. It will stay on or off as long as people are detected plus the configured follow up time.

## 20. Reset the detector

If the permanent sabotage protection is activated, the detector can be released again as follows:

- Switch off the power supply and switch it back on
- Let the sensor to initialize for 31 to 59 sec.
- Switch off the power supply again
- Apply power again and wait for the self testing
- Press the unlock

With this procedure, the remote control programmed values are not deleted (before activation of the sabotage protection).

Alternatively, the detector can be reset in this way:

- Switch off the power supply
- Set potentiometer 1 to "test" and potentiometer 2 to "SUN"
- Apply operating voltage

Except of the INI ON/OFF setting, the detector will be reset to factory setting or the setting of the potentiometer.

Pushing the "RESET" button on the remote control, in opened mode, will delete all of the values which was set by the remote control (beside of INI ON/OFF) and set the detector back to it's factory reset.

## 21. LED-functional indicators remote control

LED function indicators after each mains recovery (60 sec. initialisation period)			
Operating state	LED function indicators		
Double-locked	white and green shines for 5 sec. all 20 sec., afterwards initialising notification		
	Indicator unprogrammed	Indicator programmed	Indicator also when forced shutdown is activated
Standard mode	–	Red flashes quickly	Every 5 sec., 4 x white, red and green in quick succession
12 h ON/OFF active	Red and green flash	Red and green flash quickly	Every 5 sec., 4 x white, red and green in quick succession
Corridor active	Red and white flash	Red and white flash quickly	Every 5 sec., 4 x white, red and green in quick succession
12 h ON/OFF & corridor active	Red, green and white flash	Red, green and white flash quickly	Every 5 sec., 4 x white, red and green in quick succession
CdS active	–	Red and white flash	Then <u>no</u> red LED for motion detection

LED function indicators during operation	
Process	LED function indicators
Semi-automatic mode active	White is ON
Corridor active	White ON 1 sec. and OFF 4 sec. aus
Corridor and semi-automatic mode active	White ON 4 sec. and OFF 1 sec.
12 h ON/OFF function active	Red and green flash alternately
IR command	White flashes once
IR-command "Open" and Sabotage active	white and green flashes once
Permanent on/off	red flashes